

111199 MB

ORIGINAL

# Pain Suppression by Peripheral Nerve Stimulation Part II. Observations With Implanted Devices

J. A. Picaza, M.D., B. W. Cannon, M.D.  
S. E. Hunter, M.D., A. S. Boyd, M.D., J. Guma, M.D. and D. Maurer, B.S.E.E., M.S.B.M.E.

*Department of Neurosurgery, University of Tennessee, College of Medicine, Memphis, Tennessee*

Twenty-three patients underwent implantation of a stimulator system and were followed for 6-20 months. Twenty patients estimated between 50% and 100% pain relief. The effect was largely consistent and reproducible. Reduced drug intake and improved social performance were associated with subjective improvement. The surgical technique is given, complications are analyzed and parameters are discussed.

INTEREST of the clinical neurosurgeon in electricity as a way to modify pain is rather recent. It was especially stimulated by the work of Melzack and Wall<sup>30</sup> who proposed the gate control theory which provided a rationale to explain sensory input control at the level of the spinal cord.

Wall and Sweet<sup>53</sup> observed the effects of transcutaneous peripheral nerve stimulation on 18 patients that led Sweet and Wepsic<sup>50</sup> to implant a radio frequency device in

an attempt to prolong the benefit. Their patient, after receiving much relief, gradually showed decreased effect that led them to remove the device nine months after implantation. In a later communication, the same authors<sup>49</sup> mentioned 12 patients who had undergone implantation but they provided little analysis of their observations. Meyer and Fields' work<sup>31</sup> seems to reinforce these findings.

The development of the dorsal column stimulation concept by Shealy and associates<sup>42,43</sup> may be considered an extension of the same rationale and has found support among other authors. A rather different approach moved Sheldon<sup>44</sup> to implant in the gasserian ganglion in a case of trigeminal neuralgia in an attempt to obtain a refractory state of this structure.

Throughout these trials, much has been learned from other surgeons who simultaneously have been developing techniques for the implantation of stimulators on the

carotid sinus,<sup>4</sup> phrenic nerve, bladder and motor nerves,<sup>29</sup> and of heart pacemakers,<sup>1</sup> as well as from the experimental fields of neuroelectric research.<sup>39</sup>

### Patients

In a series of randomly selected pain patients who were treated with transcutaneous stimulation of a peripheral nerve, many indicated significant improvement in their level of comfort. The participating subject defined comfort as a gross lessening of pain. The group claiming the most benefit continued to be periodically stimulated. The use of battery-operated portable stimulation devices provided the opportunity to observe patients' responses in their natural habitat. These observations have lasted from weeks to months. A number of patients tested remained dependent on stimulation for satisfactory relief. Twenty-three of this group, even though they realized the uncertainties of an experimental approach,

This project has been partially supported by the Medical Research Division, Medtronic, Incorporated, Minneapolis, MN.

Reprint requests: Dr. J. A. Picaza, University of South Florida, Section of Neurosurgery, Veterans Administration Hospital, 13000 North 30th Street, Tampa, FL 33612

KEY WORDS: electrical stimulation • intractable pain • peripheral nerve implant • pain suppression • peripheral nerve stimulation.

ions.  
tech-  
1965,  
usual-  
fibre  
Brain  
lation  
odes  
nica-  
ng; A  
1968,  
A hu-  
vision.  
al col-  
Dallas,  
rrrent-  
1 skin.  
eering.  
Control  
ulation  
39, 26:  
Treat-  
ulation  
Trans.  
33:103-  
Tempo-  
Science  
resents  
ents of  
hed in  
further  
of in-  
subse-  
The re-  
ncy on  
ression  
placebo  
proved  
ould be  
a better  
nce of  
ch pres-  
till used  
ters and  
did ex-  
ion train  
that ap-  
cases of  
phenom-

agreed to surgical implantation of a stimulation device.

The study included 12 males and 11 females aged 30 to 69 years who underwent surgery during a 20-month period. Table 1 includes their pertinent clinical information. These patients were extensively tested transcutaneously before implantation was offered. All but one had long-standing intractable pain (at least two years' duration) and had undertaken all currently accepted medical and surgical procedures to no avail. Eight had undergone surgery for proved ruptured lumbar disks. Only one had a pending workmen's compensation settlement.

As a group, the patients' pain patterns covered most body areas. Psychologic factors (psychiatric status, secondary economic gains, personality manifestations, Minnesota Multiphasic Personality Inventory results, testing, etc.) were evaluated independent by a psychiatrist. Most patients were generally considered healthy.

Our working hypothesis was that the electrical input provided through the intact peripheral nerves may reach areas having hyperexcitability states in the central nervous system and modify them favorably. Finding the best input pathway and identifying the optimal electrical parameters was established during the period of transcutaneous testing. To reproduce the desired test effect in a more efficient, convenient way, the surgical implant of a stimulator device was though desirable. Due to a scanty knowledge of the clinical characteristics of the patients who could benefit from direct peripheral nerve stimulation, we felt that surgery was justified only on the basis of the following criteria:

1. Patients had been consistently benefited by transcutaneous stimulation but which had somehow proved inconvenient for long-term application
2. Results observed over a prolonged period of time
3. Conventional therapy, exclusive

Number	Occupation	Diagnosis	Pain location and duration	Previous surgical procedures
1	animal trainer	neuropathy (compression)	legs, 2 yrs.	lam. (2) fusion
2	housewife	syringomyelia	trunk	lam. (2)
3	insurance adjuster	trauma myelo.	arms, neck 9 yrs.	lam. (2) fusion
4	teacher	post spinal surg.	back, leg 3 yrs.	expl. (2)
5	meat cutter	post baker's cyst	leg, 6 yrs.	expl. (2)
6	storekeeper	spinal sprain	trunk, 13 mo.	myelogram
7	crippled (M.D.)	post-spinal (disc)	hip, leg 6 yrs.	D & F rhizotomy
8	housewife	atypical facial N.	face, 2 yrs.	neurot. clin.
9	elect. cont.	chron. arthrop.	knee, 5 yrs.	lam. (2) sympath. (2)
10	C.P.A.	post spinal surg. (disc)	back, leg 18 yrs.	lam. (2) fusion
11	police lt.	post spinal surg. (disc)	neck, shoulder, head, arm, 5 yrs.	lam. fusion
12	construction	post spinal surg. (disc)	back, legs 5 yrs.	lam & fusion expl.
13	mechanic	sural neuritis (wound)	leg, post 1 yr.	expl.
14	social worker	phantom limb pain	phantom, 5 yrs.	none
15	realtor	amputation stump pain	stump, 3 yrs.	neurot., sciatic femoral
16	accountant	cranio-facial neur. (Ramsay Hunt?)	V, VIII, X, C1-2	VII decomp., VIII intermedium IX & C sect.
17	IBM operator	post spinal surg.	back, leg, 8 yrs.	lam.
18	director, college dept.	post spinal surg. (disc)	leg, 9 yrs.	lam. (2) expl. (1) rhizotomy, sympathectomy myelogram
19	clerk	post trauma arthropathy	leg	myelogram
20	housewife	causalgia minor	right lower extremities 2½ yrs.	neurotomy, arthrodesis
21	cashier	spondylarthrititis	trunk, legs, 20 yrs.	none
22	nurse	spondylolisthesis and radiculitis	back, groin, leg	lam. fusion
23	housewife	post spinal surg.	back and leg	lam. (2) sympathectomy, rhizotomy, myelogram

of narcotics, had failed to relieve patient's pain for at least one year

4. Patient himself felt it worthwhile to receive the implant (informed consent).

Table 2 outlines the general surgical data of these patients.

#### Implanted Stimulating System

A special surgical device was designed for surgical implantation.\* This stimulation system (Fig. 1) consists of an externally worn min-

\* Manufactured by Medtronic, Inc., Minneapolis.

ature pulse-modulated radio frequency transmitter which is magnetically coupled (by an antenna coil) through the skin to the coil of an encapsulated implanted receiver. The receiver delivers the received and detected electrical pulse to the lead wire and thereby to the electrode wrapped around the nerve.

The units are packaged, sterilized with ethylene oxide and "degassed" at least three days before use. Other versions of this system have been designed and used for such applications as multiple nerve stimulation (two circuits placed in

a single device) (e.g., stimulation of both sciatic nerves). A functional block diagram of the system is shown in Fig. 2.

**Method**

The location of the implant follows some general rules. The receiver should be implanted subcutaneously in the anterior aspect of the body where the antenna can be easily placed over it and manipulated by the patient. The subclavicular fossa (Fig. 3) and the lower quadrant of the abdomen (Fig. 4) are first choices. We have found the lateral costal area below the nipple line particularly suitable for women because the antenna can be held by a long-line brassiere.

During preparation of the subcutaneous pocket to hold the receiver, the best instrument is the surgeon's finger. The implanted receiver may, in unusual cases, cause fluid formation or discomfort. The receiver should not be covered by subcutaneous fat more than 1 cm. thick, as the electrical coupling may be decreased with consequent unreliable stimulation.

Tunneling for passage of the conductive lead wire is done either subcutaneously or through muscular masses proved to be an easy procedure and well tolerated. Tunneling is easily done with uterine forceps or the device developed by

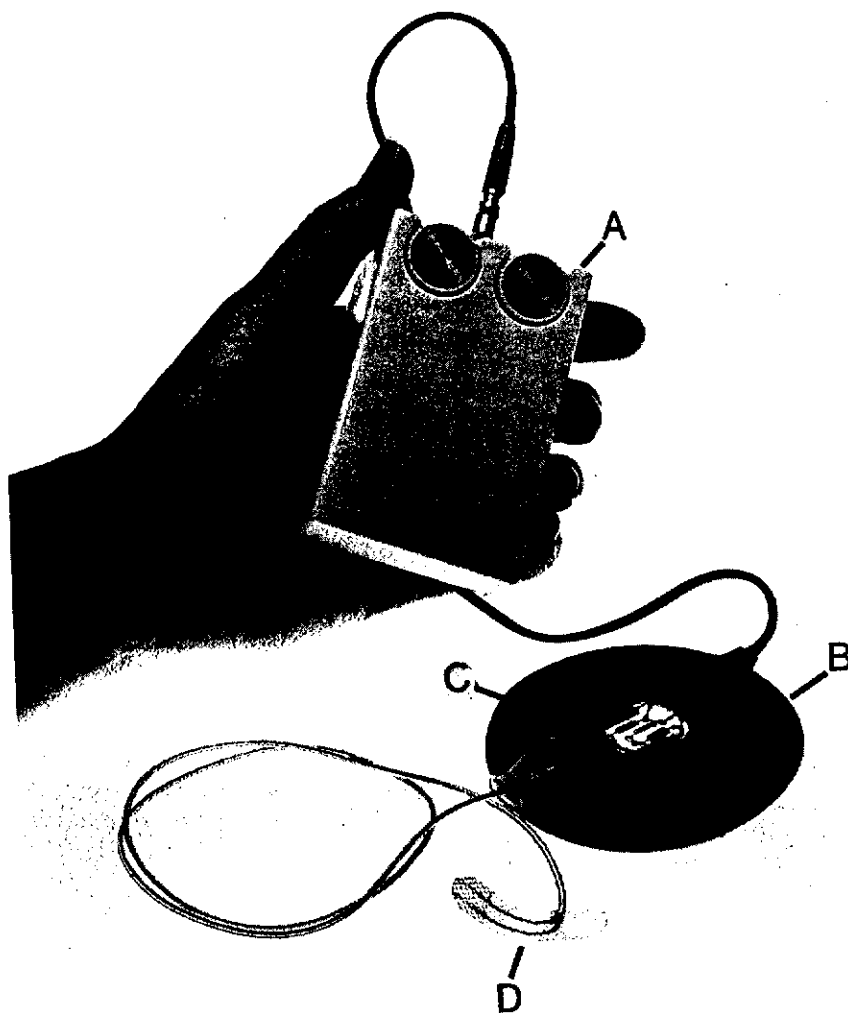

FIG. 1. Peripheral nerve stimulator system consisting of A. external transmitter 455-KHz pulse-modulated carrier sufficient to develop 8-v stimulus at receiver through coupling distance of 1 cm, B. antenna, C. receiver encased in epoxy and coated with thin medical-grade silicone rubber to reduce foreign body reaction and D. wraparound nerve electrode using platinum tinsel wire.

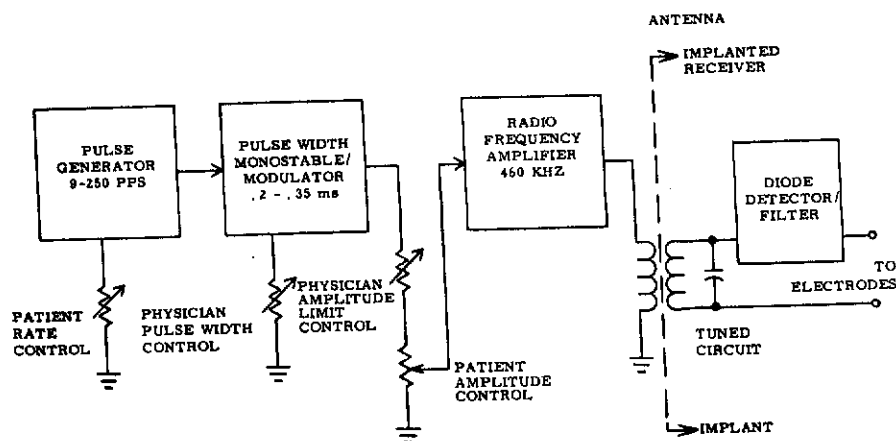

FIG. 2. Functional block diagram of peripheral nerve stimulator (transmitter) system.

Burton and described elsewhere in this monograph. The lead is passed through gently, avoiding direct grip by the forceps. A Penrose drain enveloping the lead can be used to facilitate the passing maneuvers. A loop of the lead wire can be held loosely together with one suture to provide slack that absorbs any possible stretching effect of the lead during body movement (Fig. 4C).

The ulnar nerve is easily approached through a 5-cm incision overlying the nerve and proximal to the epitrochlear eminence. The nerve and the muscular septum run

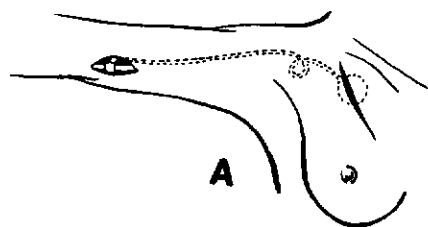

FIG. 3. Ulnar nerve implant with receiver located in infraclavicular fossa.

together at this point and no other delicate structures lie nearby. The choice approach to the sciatic nerve is immediately at its exit from the sciatic notch (Fig. 4A). A split muscle approach exposes not only the greater sciatic nerve but also the lesser sciatic, obturator and pudendal nerves, increasing the surgeon's choice of input for the specific case (Fig. 4D). The connecting lead wire is tunneled through the gluteus muscles and brought to the subcutaneous tissue near the anterior iliac spine, gaining access to the right lower quadrant of the abdomen or the anterior subcoastal region.

The electrode should be placed surrounding the nerve, avoiding any possibility of constriction. A good practice is to allow the electrode to be loose enough to permit easy sliding on the nerve. Fine polyethylene has been our suture choice. Anchoring the electrode to the adjacent fibrous interbrachial septum has consistently been done in our ulnar implants with the hope of preventing traction on the nerve during arm movements. In cases where this hazard was felt less likely to happen, the electrode was left floating in the soft tissue and some slack in the lead was allowed (Fig. 5).

Hemostasis throughout the surgical procedure should be perfect, as any bloody residuals increase the chances of fluid collection, hematoma formation or infection.

#### Clinical Results

When they had received their implanted stimulation device, this group of patients were fully in-

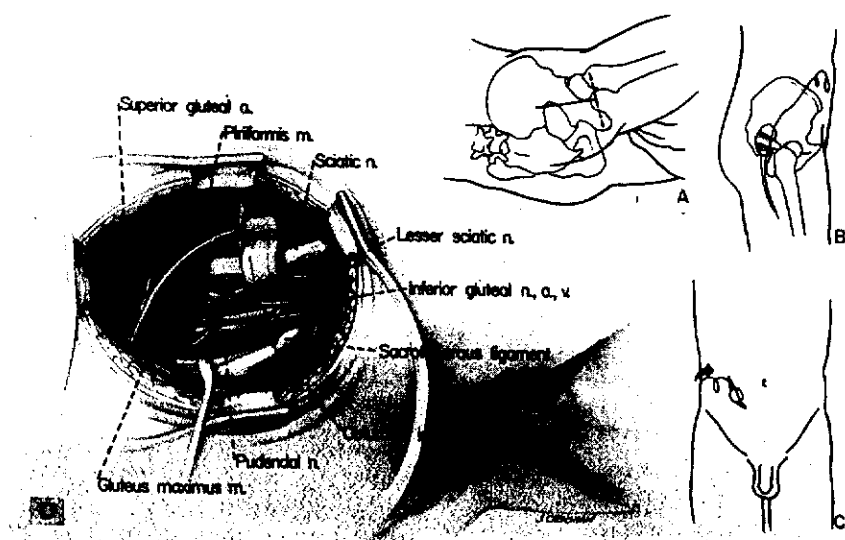

FIG. 4. Sciatic nerve implant technique. A. 10-cm incision perpendicular to midportion of ischiochanteric line. B. McBurney incision for receiver pocket. C. Implanted device in position. D. Split muscle approach to sciatic notch.

structed on how to use the instrument, how to find their sensory threshold and the effective ranges of stimulation (see Part I of this article). All patients were syste-

matically evaluated during office visits every three months.

The criterion for evaluating results has been the self-estimate of the patient's perceived pain-modi-

TABLE 2  
SURGICAL DATA

Case number	Nerve implanted	Hz	Optimal stimulation parameters*		Complications and treatment
			Intensity	Mode	
1	sciatic	0	0	0	no stimulation (removed)
2	ulnar (L)	2/s	subthresh	constant	inflammatory reaction (removed)
3	ulnar (L)	20	subthresh	constant	none
4	ulnar (L)	10	threshold	constant	none
5	peroneal (L)	50	threshold	P(night)	none
6	ulnar (L)	25	subthresh	P(night)	none
7	ulnar (L)	50	threshold	PRN	tenderness (removed)
8	occipital	variable	threshold	constant	none
9	ulnar (R)	10	suprathresh	constant	tender, weak ulnar nerve
10	sciatic (R)	50	subthresh	P(day)	tenderness (relocated)
11	occipital	25	threshold	P(day)	skin reaction, allergy
12	sciatic (L)	25	suprathresh	(tid)	none
13	sciatic (R)	25	threshold	P(day)	dislocation (relocated)
14	sciatic (L)	variable	suprathresh	PRN	none
15	sciatic (L)	12	threshold	constant	none
16	cervical plexus	15	suprathresh	P(day)	none
17	sciatic (R)	8	threshold	constant	tenderness
18	sciatic (R)	7	threshold	P(day)	tenderness (relocated)
19	sciatic	10	threshold	P(day)	tenderness (relocated)
20	sciatic	7	threshold	P(1hxdy)	none
21	bilateral	120	threshold	constant	none
22	sciatic + pudendal + obturator	7	threshold	constant	tenderness
23	ulnar (R)	100	threshold	constant	tenderness

TABLE 3  
PAIN EVALUATION PROFILE

Grade	Pain time (% per day)	Pain intensity	Factors activity decreased (%)	Medication (abuse potential)	Pain-associated behavior disorder
0	0	none	0	none	normal
1	25	mild	25	nonaddictive*	slight
2	50	discomfort	50	low**	moderate
3	75	distressing	75	moderate†	severe
4	100	excruciating	100	high‡	extreme

\* Substances listed in Schedule V of the Bureau of Narcotics and Dangerous Drugs  
 \*\* Substances listed in Schedule IV of the Bureau of Narcotics and Dangerous Drugs  
 † Substances listed in Schedule III of the Bureau of Narcotics and Dangerous Drugs  
 ‡ Substances listed in Schedule II of the Bureau of Narcotics and Dangerous Drugs

TABLE 4  
RESULTS

Case number	Follow-up months	Preop grades	Postop grades	Patient's validity
1	20	4 3 4 4 1	0 0 0 0 0*	+
2	15	4 3 4 4 1	0 0 2 0 1	+
3	19	4 3 4 4 4	0 0 0 0 0	+
4	16	4 2 2 3 0	2 2 2 1 0	+
5	17	4 3 3 4 4	0 1 3 2 1	+
6	15	4 3 1 0 0	0 1 1 0 0	+
7	15	3 3 7 4 3	0 1 7 1 1	+
8	14	4 3 3 3 4	1 1 0 1 2	+
9	11	4 4 4 2 2	4 4 3 2 2	+
10	10	4 3 2 4 1	1 2 1 2 0	+
11	10	4 1 2 2 2	0 1 0 1 2	+
12	10	4 2 4 3 3	2 1 2 3 3	-
13	10	3 2 1 1 2	0 0 0 0 2	+
14	10	4 4 2 4 0	0 0 0 0 0	+
15	10	4 4 4 3 2	2 2 3 3 2	-
16	10	4 3 4 3 3	2 1 4 4 4	-
17	10	4 4 4 3 2	0 1 2 1 2	+
18	9	4 4 3 4 3	1 1 2 1 3	+
19	8	4 3 3 1 1	2 2 2 0 1	+
20	7	4 4 4 4 4	0 0 2 1 1	+
21	6	3 3 2 4 3	2 2 2 4 3	-
22	6	4 4 4 4 3	3 4 4 4 3	+
23	6	4 3 2 0 1	2 2 2 0 1	-

\* defective implant

"pain profile" to identify the patient's status both preoperatively and postoperatively.\* The first and second digits (grade) indicate the individual's pain, the third the decrease in social activities and the fourth and fifth the medical aspects. The patient's validity was considered high if his claimed improvement was corroborated by equivalent improvements in the social and medical aspects. Table

4 gives the patients' evaluations using this pain profile.

In this limited number of observations, not much can be concluded in relating diagnosis to results. A trend may be noted, however, in the 11 patients who had multiple surgery for spinal disk disorder. Only two of these patients claimed less than 75% improvement. The two patients with amputation pain were benefited, and in one with pain in the phantom foot, the pain disappeared without disabling effects and the phantom remained unmodified. Stabbing pains in the thigh stump of the other patient

\* Creation of this pain profile was aided through discussions with Norman Shealy and Charles Ray.

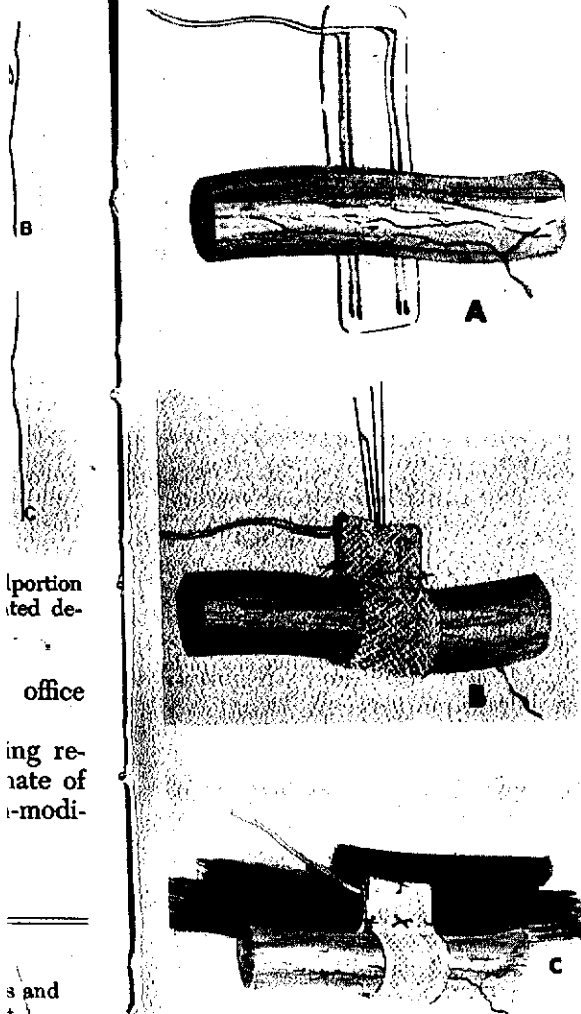

FIG. 5. Detail of electrode placement. A. Relatively avascular area of nerve; bare electrode turned toward nerve. B. Electrode held in position by mosquito forceps and stitches. C. Tacking to nearby fibrous septum.

ifying benefits expressed as a percent. This self-estimate was further evaluated in terms of the patient's functioning in family-social affairs and daily activity and of changes in medication and general behavior. Preoperative assessment is compared in this report with the status of the patients at the last follow-up visit. A comparative study was possible for all patients except one in whom the implanted device failed to produce stimulation.

Table 3 shows our method of establishing a five-figure number

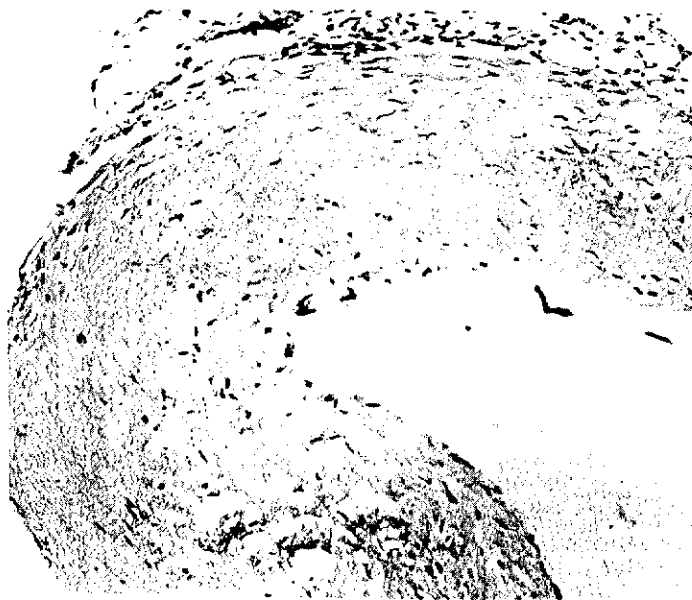

FIG. 6. Photomicrograph of fibrous tissue enveloping well-tolerated device five months after implantation.

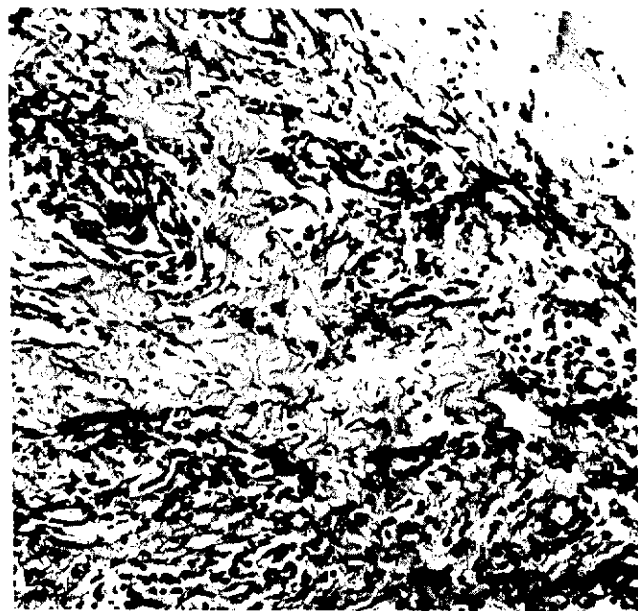

FIG. 7. Photomicrograph of chronic inflammatory tissue, probably foreign body reaction, surrounding nonworking electrode six months after implantation.

disappeared, but some degree of stump tenderness persisted.

The 23 patients in this series were implanted on the nerve that, according to the patient, most effectively suppressed pain during testing. In 14 patients the area of referred pain and the most effective nerve stimulated overlapped. In nine patients the optimal nerve was "remotely" located from the area of pain. In three of the latter patients the ulnar nerve strongly suppressed pain in the homolateral leg and in another the contralateral leg. In three patients stimulation of one ulnar nerve eliminated intense pain in the posterior upper trunk and in another there was elimination of pain in the contralateral ulnar distribution. Another had atypical facial pain (anesthesia dolorosa) and received benefit from occipital nerve stimulation. The patient with intractable head and ear pain received much benefit from cervical plexus stimulation.

#### Complications

In this series, the complication rate should be considered high. Three devices had to be removed, one due to late infection and an-

other due to malfunction and the last was requested by a patient whose pain had disappeared. Post-operative local tenderness has been frequent and three patients had to have revisions.

Ten of the 23 patients showed some degree of complication related to the procedure (Table 2). In one, no stimulation was ever obtained, probably the result of defective placement. In two, motor weakness made close observation necessary, but it cleared in time. In six, reoperation was needed.

Most complications were largely mechanical and fortunately correctable, e.g., a kink in the lead wire pressing into the skin, irritation of the skin overlying abdominal wall receivers and probably a tight electrode around an ulnar nerve. One patient noticed inconsistent stimulation following a motorcycle accident, and on roentgenographic examination the electrode appeared to be dislocated. Three patients had local skin reaction, apparently due to skin allergy, which subsided spontaneously.

Experimental work<sup>13,25</sup> strongly suggests that Silastic may be an ideal material, particularly if

loosely wrapped around the nerve. Histologic observations in some of our patients, however, have shown the development of a rather thick, fibrous envelope around the device, including the nerve (Fig. 6). In one patient, a considerable amount of round cell activity was noticed up to six months after the implantation although he remained asymptomatic (Fig. 7).

Accumulating experience with the use of artificial devices on the nervous system seems to show a moderate but higher level of problems than with cardiac pacemakers. According to Medtronic, Inc.,<sup>29</sup> about 15% of motor nerve implants and 25% of dorsal column stimulators have shown some evidence of disturbance. A word of caution is raised.

Only two patients had permanent morbidity. After 11 months one patient still showed weakness in the ulnar distribution. Another had sepsis six months postoperatively due to a staphylococcus, coagulase-positive infection; the device unfortunately had to be removed six months later while the patient was receiving effective pain suppression.

### Addiction

To some degree, the capability of reducing or discontinuing drug medication following a surgical procedure for pain may be considered an index of the effectiveness of the treatment. In this series of long-standing pain problems, some degree of drug addiction was present in most of the patients. This became particularly evident when medication withdrawal was attempted following the implantation. In at least four patients, severe depression and anxiety appeared and necessary precautions had to be taken. These patients admitted receiving pain suppression in spite of these symptoms. One case was particularly dramatic because of the enormous amount of medication the patient had taken during the nine years prior to implantation. At the time of this report, only three patients were still receiving some narcotics. Of the remaining patients, four were receiving minor amounts of nonnarcotic analgesics, ten were receiving tranquilizers and six were receiving no medication.

### Predictability

The apparent benefit noticed during the preoperative transcutaneous stimulation tests remained basically unchanged in 12 implant patients throughout the time of our observations. The degree of benefit noted following surgery was similar to what had been obtained previously by transcutaneous testing. These patients appear to have gained from the implant primarily in terms of convenience and efficiency. Six patients have shown sustained beneficial aftereffects from constant stimulation. Although the implanted stimulator did not function, one patient continued to receive transcutaneous stimulation and the pain gradually subsided during a period of six months. At the time of this report (one year later) he remains asymptomatic. This remission, however, could also be related to the im-

TABLE 5  
OPTIMAL STIMULATION PARAMETERS

	No. of cases
Rate per second	
1-10	8
11-50	10
51-120	2
variable	2
Intensity	
subthreshold	3
threshold	15
suprathreshold	4
Mode	
continuous	10
periodic	10
as necessary	2

provement of other symptoms of his preexisting peripheral neuropathy.

On the other hand, another patient remained pain-free for three months following the removal of the device in spite of continuous manifestations of his syringomyelia; the pain returned later, however. Four patients gradually increased their estimation of the benefit to total relief during the time of observation. On the other hand, six patients showed a drop in benefit during the same period.

### Parameters

The "optimal" parameters found are included in Table 5. Several patients seemed to have a preference for the low rates, many times at the lower limit of transmitter capability. In our experience, low rates and rather low voltage have been more pleasant. The 1-10 Hz range was the final choice of eight of our patients, and 11-50 Hz for another ten. Low frequencies may have some further conveniences such as economy of power energy and the theoretical possibility of being effective in patients with peripheral nerve damage in whom high frequency may fail.<sup>9</sup> Frequencies below 1 Hz have not been explored in this study. On the other hand, frequencies as high as 200 Hz were tried, but patients usually rejected those above 100 Hz. Benefit to be found when stimulating at or below sensory threshold (sub-

liminal) has become important. The patient shows neither sensory nor motor interference during stimulation, making the procedure nearly ideal. Seven patients found the intensity optimal at levels of sensory threshold, and three found subliminal stimulation most satisfactory.

Intensity of electrical stimulation seems important. Theoretically low intensities may have a better chance of stimulating large-sized fiber groups, with associated physiologic implications. We found in our observations that the higher the intensity the better the chances of stimulating the small-sized fibers, with the possibility of evoking unpleasantness or even pain sensation. The trend seems to be that the more acceptable clinical responses are found on the low rate and intensity ranges. Sweet and Wepsic<sup>49</sup> noted good results with stimulus durations of 0.1-0.2 msec and 20-120 Hz. Four of their patients used setting at suprasensory threshold and one used it variably. Ten patients elected continuous stimulation day and night. Ten other patients came to use it periodically on a regular schedule. Six of the latter used it continuously during the daytime, one used it at night and one used it systematically three times a day for one hour. Finally, four patients used the stimulation only when the pain appeared: two used it irregularly day or night, one came to need it about one hour every two days and the other found it necessary for only about one hour approximately every two weeks.

### Discussion

*Psychological factors:* The psychiatric opinion obtained in all patients in this study revealed no patient that could be considered a primary psychiatric problem. Moreover, all but four showed objective clinical evidence of nervous tissue damage as a source of pain. Therefore, the reliability of most patients' evaluations of their pain may be considered high.

In spite of the rather heavy or-

ganic background of the pain in this group of patients, the question remains how much of a role psychologic factors could be playing in the results. Hypnotic effects may easily be dismissed, but suggestion effect cannot. The strongly suggestive effect of electric tingling has been recognized by psychiatrists and exploited by charlatans for perhaps centuries. Long-range effects could be explained by the reinforcing of perceived stimuli. The fact that we have observed patients who claimed benefits while receiving subliminal stimuli yet have had pain return during placebo tests certainly lessens the importance of mere suggestion effect. It seems quite improbable that a rather simple method such as peripheral nerve stimulation has a stronger suggestive value than multiple surgical procedures, hospitalizations, drugs and even psychiatric treatments such as most of these patients have previously received. Collateral psychologic gains can also be considered. Economic gains may not be significant in this series, since only one patient involved a workmen's compensation settlement.

On the other hand, the possibility of other conscious or unconscious psychologic gains of importance may play no role here in view of the open acceptance by all patients of pain suppression by electronic stimulation. In addition, reduction or discontinuation of drugs was considerable and in many life-style and productivity improved. Unsustained effect with the passage of time is a characteristic of suggestion (placebo). A sustained benefit observed longer than a year in this preliminary report considerably decreases suggestion as an important factor unless we are dealing with an extraordinarily suggestive method previously unknown. Further observations in time will be necessary before a final opinion may be given.

None of these patients ever complained of any worsening of their pain during or following stimula-

tion. The positive fact that seems to be emerging is the highly predictive value that the preoperative transcutaneous test appears to have. Seldom does a patient have the opportunity to experience beforehand the benefit he will receive from an operation. The advisability of surgery comes, therefore, from the patient's own request after being fully informed.

*Difficulties encountered:* The technicalities of implantation have not been a major problem. However, the establishment of optimal electrical parameters of stimulation is far from settled. If it is a matter of personal preference, variations in efficiency or both is not clear but patients end up with different settings when permitted to find their own electrical parameters.

*Potential hazards:* Clinical morbidity as related to the procedure seems to be low in this series, as the only permanent side effect significant to the patient was ulnar weakness in two patients.

A final theoretical hazard to take into consideration would be long-term ill effects that could be related to the peripheral nervous system using parameters similar to ours. The possible deleterious effect of electrical stimulation of the nervous system has been recognized for some time. Horsley and Clark<sup>21</sup> recognized in 1908 the possibility of electrolytic effect. This injury is related to the total quantity (coulombs) of electricity passed through the tissue and the use of unidirectional direct currents. We have attempted to preclude this injury primarily by the use of biphasic stimuli and minimal currents. "Thermal" injury is usually related to frequencies above 200 kHz and to the total energy measured in watts.<sup>26</sup>

Our extremely low frequency of stimulation (with short pulse duration) obviates thermal complications. In general, we have stayed within the nondestructive electrical parameters known by experimentation.<sup>32</sup>

Recently the kindling effect

has been described as a process whereby low-intensity, repetitive electrical stimulation of the nervous system may result in long-term changes in neural organization.<sup>17</sup> In the brain it may result in seizures, depending on the stimulation site, but nothing is known of the effects on the peripheral nervous systems or spinal cord. Our observations for up to two years fail to reveal undesirable side effects. Moreover, our experience with two patients who were without pain for three months following removal of the device suggests that some degree of permanent reorganization in the nervous system functioning may have taken place, this time favorable to the patient.

*Working hypothesis:* Our working hypothesis originated from extensive clinical observations. We find a unifying explanation for chronic pain as a "central hyperexcitability state." This concept can be found in the literature on hyperpathia, central pain, dyesthesia, causalgia, etc.<sup>8,10,15,16,34,35,40,52</sup> and is supported by the physiologic findings that followed Cannon and associates<sup>6,7</sup> discovery of the "law of denervation." Although this concept will not be discussed in detail here, it has been corroborated by experimental pathophysiology.<sup>3,12,14,23,24,27,28,54,56</sup> Our results support the contention that in selected patients this state would be modifiable, e.g., by suppression through peripheral nerve stimulation. To the limited extent that we have tested the hypothesis, our findings seem to support this.

*Physiological correlates:* The effect on pain, as we have observed, after repetitive electrical stimulation, shares most of the characteristics that have been recognized within the phenomena of habituation (or adaptation) long investigated by psychologists and physiologists.<sup>5,11,19,37,38,45,46,51,57</sup> Repetitive stimulations, among other effects, show gradual suppression of the response until extinction, a discrete time period before taking effect (response latency), con-



rocess  
etitive  
rvous  
g-term  
tion.<sup>17</sup>  
in sei-  
lation  
of the  
ervous  
obser-  
fail to  
effects.  
th two  
ain for  
oval of  
ne de-  
ization  
tioning  
s time

work-  
om: ex-  
is. We  
on for  
hyper-  
ept can  
hyper-  
ia, cau-  
and is  
ic find-  
on and  
ie "law  
is con-  
a detail  
ted by  
ogy.<sup>3,12</sup>  
support  
ted pa-  
: modi-  
through  
on. To  
e have  
findings

The ef-  
served,  
stimula-  
aracter-  
ognized  
of ha-  
) long  
ists and  
<sup>51,57</sup> Re-  
g other  
pression  
action, a  
e taking  
, con-

tinued responses after discontinuation of stimulus, responses beyond the topographic area of the stimulus input and induction of responses by rhythmic stimuli at low-frequency, low-intensity parameters.

Habituation seems to be a fundamental process of a living system. It has been demonstrated in the single neuron<sup>20</sup> as well as multi-neuronal subsystems (visual, olfactory, auditory, etc.) and the brain as a whole.<sup>36</sup> Clinically, the essential phenomenon is a state of gradual depression of function until extinction takes place.

Experimental work with animals supports the contention that habituation may take place within the isolated spinal cord.<sup>2,5,18,47,48</sup> It is not due to exhaustion of the transmitter,<sup>11</sup> and it occurs at the inter-neuronal pathway somewhere near the afferent limb of the polysynaptic reflex, particularly Rexed lamina 5 where large myelinated fibers end (A-alpha subserving touch and proprioception and A-delta of III fibers from nociceptors, particularly visceral).<sup>22,41,46,47</sup> It may be logically possible that depressing or inhibitory effects induced by the quality of electrical stimulation used in our observations could decrease or suppress central states of hyperexcitability involving the nociceptive input system. These suggestions are provoking, but much work on these lines is necessary and the nature of the observed effects should as yet be considered obscure.

#### Conclusion

Unfortunately, not every case of intractable pain seems to be benefited by peripheral nerve stimulation. More insight and experience with the technique would increase the number of candidates. However, some important questions are left open and will have to be answered before the procedure may be considered open for general neurosurgical use: Are relative tolerance to the devices and apparent low incidence of important side effects going to endure over time?

At this stage in our knowledge, the procedure should be considered clinical investigation. The cost of developing the device is high and the uncertainties numerous. The neurosurgeon who wishes to proceed along this line of investigation must be willing to give rather extensive time to personal attention necessary for a fair clinical assessment and should count on the close cooperation of the bioengineer, psychologist and psychiatrist. This field of clinical research, however, seems encouraging.

#### Acknowledgments

We wish to thank Mr. Carl Payne for his technical advice and Mr. Ward Bell, Mrs. Freida Watkins and Miss Jan Hawkins for their work on this manuscript.

#### Addendum

This paper represents the observations on implanted devices for the period ending in October 1973. A re-evaluation of 50 implanted cases 6 months later revealed 34 of them reporting good (12 patients), to excellent (22 patients) results, ten mild benefit and the rest (six) none or minimal. On the almost totality of the best results a proportional improvement on life style, drop in medication and increase in activities took place. Morbidity was still low and no mortality related to the implant. Reoperation was not uncommon either for revision (four cases), implanting a second device (four cases) or removing the device (one due to intolerance and five by request after the pain disappeared). The impression, however, was that some areas of clinical application of nerve implants may be delineating.

#### References

1. Anagnostopoulos, C. E., Glenn, W. W. L.: Electronic pacemakers of the heart, gastrointestinal tract, phrenic nerve, bladder and carotid sinus: Current status. *Surgery* 1966, 60: 480-494.

2. Bazanova, I. S.: Investigation of adaptation in somatic reflex arc. *Fed. Proc. (Trans. Suppl.)* 1964, 23: T1181-T1184.
3. Black, R.: Trigeminal pain. In Crue, B. L., Jr.: "Pain and Suffering Selected Aspects." Springfield, Ill., Charles C Thomas, 1970, pp. 119-137.
4. Braunwald, N. S., Epstein, S. E., Braunwald, E.: Carotid sinus nerve stimulation for the treatment of intractable angina pectoris: Surgical technique. *Ann. Surg.* 1970, 172:870-882.
5. Buchwald, J. S., Halas, E. S., Schramm, S.: Progressive changes in efferent unit responses to repeated cutaneous stimulation in spinal cats. *J. Neurophysiol.* 1965, 28:200-215.
6. Cannon, W. B., Haimovici, H.: The sensitization of motoneurons by partial "denervation." *Am. J. Physiol.* 1939, 126:731-740.
7. Cannon, W. B., Rosenblueth, A.: "The Supersensitivity of Denervated Structures." New York, Macmillan and Company, 1949.
8. Cassinari, V., Pagni, C. A.: "Central Pain: A Neurosurgical Survey." Boston, Harvard University Press, 1969.
9. Davis, F. A.: Impairment of repetitive impulse conduction in experimentally demyelinated and pressure-injured nerves. *J. Neurol. Neurosurg. and Psychiat.* 1972, 35:537-544.
10. Dejerine, J., Roussy, G.: Le syndrome thalamique. *Rev. Neurol. (Paris)* 1906, 14:521-532.
11. Dimitrijevic, M. R., Nathan, P. W.: Studies of spasticity in man: 4. changes in flexion reflex with repetitive cutaneous stimulation in spinal man. *Brain* 1970, 93:743-768.
12. Drake, C. G., Stavrak, G. W.: An extension of the "law of denervation" to afferent neurones. *J. Neurophysiol.* 1948, 11:229-238.
13. Ducker, T. B., Hayes, G. J.: Experimental improvements in the use of Silastic cuff for peripheral nerve repair. *J. Neurosurg.* 1968, 28:582-587.
14. Eccles, R. M., Kozak, W., Westerman, R. A.: "Enhancement of spinal monosynaptic reflex responses after denervation of synergic hind-limb muscles." *Die Leitungsbahnen des Schmerzgefühls und die Chirurgische Behandlung der Schmerzzustände.* Berlin, Urban and Schwarzenberg, 1927.
15. Garcin, R.: La Douleur dans les affections organique due systeme nerveus central. *Rev. Neurol. (Paris)* 1937, 68:105-153.
16. Goddard, G. V.: The kindling effect: A precautionary note on therapeutic applications of localized brain stimulation. In Reynolds, D. V., Sjöberg, A. E. (Editor): "Neuroelectric Re-

- search: Electroneuroprosthesis, Electroanesthesia and Nonconvulsive Electrotherapy." Springfield, Ill., Charles C Thomas, 1971, pp. 37-39.
18. Griffin, J. P., Pearson, J. A.: Habituation of the flexor reflex in the rat. *J. Physiol. (London)* 1967, 190:3P-5P.
  19. Hagbarth, K. E., Finer, B. L.: The plasticity of human withdrawal reflexes to noxious skin stimuli in lower limbs. *Progr. Brain Res.* 1963, 1:65-80.
  20. Horn, G.: Novelty, attention and habituation. In Evan, C. R., Mulholland, T. B. (Editor): "Attention in Neurophysiology." London, Appleton-Century-Crofts, 1971, pp. 230-246.
  21. Horsley, V., Clarke, R. H.: The structure and function of the cerebellum examined by a new method. *Brain* 1908, 31:45-124.
  22. Hugon, M.: Transfer of somatosensory information in the spinal cord. In "Handbook of EEG and Clinical Neurophysiology," Amsterdam, Elsevier, 1971, Vol. 9, pp. 35-44.
  23. Kennard, M. A.: Sensitization of the spinal cord of the cat to pain-inducing stimuli. *J. Neurosurg.* 10:169-177, 1953.
  24. Kostyuk, P. G.: Functional changes during degeneration of central synapse. In Guttman, E., Hnik, P. (Editors): "Effect of Use and Disuse on Neuromuscular Functions: Proceedings. Symposium on the Effect of Use and Disuse on Neuromuscular Functions." Amsterdam, Elsevier, 1965.
  25. Lehman, R. A. W., Hayes, G. J.: Degeneration and regeneration in peripheral nerves. *Brain* 1967, 90:285-296.
  26. Lilly, J. C.: Injury and excitation by electric currents and the balanced pulse-pair waveforms. In Sheer, D. E. (Editor): "Electrical Stimulation of the Brain." Austin, Texas, University Press of Texas, 1961, pp. 60-64.
  27. Loeser, J. D., Ward, A. A., Jr.: Some effects of deafferentation on neurons of the cat spinal cord. *Arch. Neurol.* 1967, 17:629-636.
  28. Loeser, J. D., Ward, A. A., Jr., White, L. E., Jr.: Chronic deafferentation of human spinal cord neurons. *J. Neurosurg.* 1966, 29:48-50.
  29. Medtronic, Inc.: Personal communication, 1973.
  30. Melzack, R., Wall, P. D.: Pain mechanisms: A new theory. *Science* 1965, 150:971-979.
  31. Meyer, G. A., Fields, H. L.: Causalgia treated by selective large fiber stimulation of peripheral nerve. *Brain* 1972, 95:163-168.
  32. Mortimer, J. T., Shealy, C. N., Wheeler, C.: Experimental nondestructive electrical stimulation of the brain and spinal cord. *J. Neurosurg.* 1970, 32:553-559.
  33. Nashold, B. S., Jr., Friedman, H.: Dorsal column stimulation for control of pain: Preliminary report on 30 patients. *J. Neurosurg.* 1972, 36:590-597.
  34. Nashold, B. S., Wilson, W. P.: Central pain and the irritable midbrain. In Crue, B. L., Jr.: "Pain and Suffering: Selected Aspects." Springfield, Ill., Charles C Thomas, 1970, pp. 95-118.
  35. Noordenbos, W.: "Pain: Problems Pertaining to the Transmission of Nerve Impulses Which Give Rise to Pain." Amsterdam, Elsevier, 1959.
  36. Pavlov, I. P.: "Lectures on Conditioned Reflexes." New York, International Publications Co., 1963.
  37. Prosser, C. L., Hunter, W. S.: The extinction of startle responses and spinal reflex in man and animal. *Acta Psychiatr. Neurol. Scand. (Suppl)* 88: 1954.
  38. Pumphrey, R. J., Rawdon-Smith, A. F.: Synaptic transmission of nervous impulses through the last abdominal ganglion of the cockroach. *Proc. R. Soc. Lond. (Biol.)* 1937, 122:106-118.
  39. Reynolds, D. V., Sjöberg, A. E. (Editors): "Neuroelectric Research: Electroneuroprosthesis, Electroanesthesia and Nonconvulsive Electrotherapy." Springfield, Ill., Charles C Thomas, 1971.
  40. Riddock, G., Critchley, M.: La physiopathologie de la douleur de origine central. *Rev. Neurol. (Paris)* 1937, 68:77-104.
  41. Selzer, M., Spencer, A. W.: Convergence of visceral and cutaneous afferent pathways in the lumbar spinal cord. *Brain Res.* 1969, 14:331-348.
  42. Shealy, C. N., Mortimer, J. T., Hagfors, N. R.: Dorsal column electroanalgesia. *J. Neurosurg.* 1970, 32:560-564.
  43. Shealy, C. N., Mortimer, J. T., Reswick, J. B.: Electrical inhibition of pain by stimulation of the dorsal columns: Preliminary clinical report. *Anesth. Analg.* 1967, 46:489-491.
  44. Sheldon, C. H.: Depolarization in the treatment of trigeminal neuralgia, evaluation of compression and electrical methods clinical concepts of neurophysiological mechanism. In Knighton, R. S., Sumke, P. R. (Editors): "Pain: Henry Ford Hospital Symposia." Boston: Little, Brown and Company, 1966, pp. 373-386.
  45. Sherrington, C. S.: Experiments in examination of the peripheral distribution of the fibres of the posterior roots of some spinal nerves: Part II. *Philos. Trans R. Soc. Lond. (Biol. Sci.)* 1898, 190:45-188.
  46. Spencer, W. A., Thompson, R. G., Neilson, D. R., Jr.: Alterations in responsiveness of ascending and reflex pathways activated by reiterated cutaneous afferent volleys. *J. Neurophysiol.* 1966, 20:240-252.
  47. Spencer, W. A., Thompson, R. F., Neilson, D. R., Jr.: Response decrement of the flexion reflex in the acute spinal cat and transient restoration by strong stimuli. *J. Neurophysiol.* 1966, 29:221-239.
  48. Spencer, A. W., Thompson, R. F., Neilson, D. R., Jr.: Decrement of ventral root electrotonus and intracellularly recorded PSPs produced by iterated cutaneous afferent volleys. *J. Neurophysiol.* 1966, 29:253-274.
  49. Sweet, W. H., Wepsic, J. G.: Control of pain by focal electrical stimulation for suppression. *Ariz. Med.* 1969, 28:1042-1045.
  50. Sweet, W. H., Wepsic, J. G.: Treatment of chronic pain by stimulation of primary afferent neuron. *Trans. Am. Neurol. Assoc.* 1968, 93:103-107.
  51. Thompson, R. F., Spencer, W. A.: Habituation: A model phenomenon for the study of neuronal substrates of behavior. *Psychol. Rev.* 1966, 73:16-43.
  52. Trousseau, A.: "Clinique Medicale Hôtel Dieu de Paris." Ed. 5, Paris, J. B. Bailliere, 1877.
  53. Wall, P. D., Sweet, W. H.: Temporary abolition of pain in man. *Science* 1967, 155:108-109.
  54. Ward, A. A., Jr.: "Nerve as a Tissue." New York, Harper & Row, 1966.
  55. Ward, A. A., Jr., Schmidt, R. P.: Some properties of single epileptic neurons. *Arch. Neurol.* 1961, 5:308-313.
  56. Westrum, L. E., White, L. E., Jr., Ward, A. A., Jr.: Morphology of the experimental epileptic focus. *J. Neurosurg.* 1964, 21:1033-1046.
  57. Wickelgran, B. G.: Habituation of spinal motoneurons. *J. Neurophysiol.* 1967, 30:1404-1423.

### Discussion

#### Q. Paul

Was there any noticeable difference between the character the pain relief obtained by those patients who had the unit on continuously as opposed to that group which used it on an intermittent or PRN basis?

#### A. Cauthen

My group was largely an outpatient population and they were encouraged to experiment with a

device at home. I was purposely non-directive and non-committal about what they might expect or what would be optimal, stating that we were trying to learn from the patient. I can't answer the question about continuous versus intermittent stimulation.

#### A. Laws

We've had no patient who has used the stimulator continuously, although we have had a number of patients who say that their pain relief, when it occurs, is only while the stimulator is turned on. They are a minority and most patients have persisting pain relief following a period of stimulation. I would say that in general, the pattern is one of using the instrument for 15 minutes or half an hour, three or four times a day. I am not aware of any patient who uses it all the time.

#### A. Picaza

During the pre-operative testing period, usually taking several weeks as an outpatient, the principal degree of relief I saw would be seen post-operatively, with the exceptions of the few cases that either very gradually declined over time or very gradually showed an increase over pre-op results. So that you have the three possibilities.

#### Q. Ray

One very common observation reported with the use of these devices is that it seems to take some period of time for the stimulation to become effective and the effect usually lasts considerably after the termination of stimulation.

#### A. Cauthen

At the University of Florida, Dr. Charles Vierck has initiated studies in monkeys previously trained to carry out a bar-pressing experiment in response to pain. Vierck's study involves peripheral extremity stimulation in monkeys previously trained to interrupt a painful stimulus by bar pressing. The monkeys show markedly diminished bar-pressing response after transcutaneous nerve stimulation. This response is maintained after transcutaneous nerve stimulation is

stopped and apparently is even maintained in some subjects for 24 hours. These results are hard to understand and possibly hard to accept, but this is what his report is. So, there is a degree of objectivity in this kind of experiment.

#### A. Nashold

I think there may be an explanation to some of these persistent effects seen after cessation of stimulation from involvement of the autonomic nervous system. There's no question that stimulating dorsal columns, peripheral nerves, and so on activates the autonomic system and this activation persists for some time after cessation of stimulation.

#### A. Bloedel

I would agree. I think the particular implication here is that the important interactions may be supraspinal. We're all aware that these regulatory mechanisms are in part controlled by campal-hypothalamic interactions. And in these regions of the central nervous system, prolonged interactions evoked by peripheral stimuli are very common.

#### A. Richardson

We have shown quite clearly that there is a thalamic gate mechanism that is manipulated by either transcutaneous peripheral nerve stimulation or dorsal column stimulation of the spinal cord of the cat. The technique is to use sciatic nerve input and measure either evoked responses or single cell responses in the parafascicularis. We use as a comparative test method the effect on the evoked response of intravenous morphine and we can relate the effects of either dorsal column stimulation, peripheral nerve stimulation or transcutaneous stimulation to the portion of the evoked response abolished by intravenous morphine. Regarding the need to prove whether or not electrical stimulation is capable of relieving pain, this in some ways reminds me of a discussion I listened to one time as to whether there was any noise if there was nobody there to hear it. I agree with Dr. Sheldon's comment that

what is important is that the patient is relieved of the pain; in a real sense, it's difficult to find any better criterion.

#### A. Krainick

Besides DCS, we have some experience with transcutaneous stimulation to reduce pain. During percutaneous electrode DCS test stimulation, acutely triggered test pain, as for instance pin pricks, can be blocked in addition to the diminution of chronic pain. We use transcutaneous stimulation in two different situations. First, during simple operative procedures and then for treatment to avoid triggered pain. Then, secondly, in peripheral pain syndromes as for instance trigeminal neuralgia and other applications such as for wound pain after surgery and chronic back pain. As shown on the slide for dental applications, we stimulated with electrodes over a trigeminal point and the mandible. The stimulation starts some minutes before the treatment. In all 30 cases, a local anesthesia would otherwise have been necessary. A preliminary note on this subject will be printed soon. In four patients minor operations of the hand, such as median nerve compression syndrome, were performed using stimulation with two electrodes placed further up on the arm. Under stimulation, all of the procedures are possible except when manipulating the nerve itself. All the other treated patients had pain syndromes before stimulation was started. In the next three groups, lumbar plexus stimulation was mostly applied to diminish pain during physiotherapeutic treatments. The after benefit lasted only a short time. As a summary of our observations, it seems that acute triggered pain during operation is better controlled than chronic pain syndrome, by the use of the TNS.

#### A. Wepsic

I thought this group might be interested in some of the results that have been achieved at the Forsythe Dental School at Harvard in trying to establish the relationship

of dental pain to stimulation and transdental stimulation. This technique involved not stimulating the trigeminal nerve in any particular place but actually stimulating individual incisors and was carried out there with Dr. Leif Backlin and myself. We found that it is possible, in spite of the fact that the teeth are innervated by essentially only C fibers, to stimulate across the tooth and produce analgesia within that tooth. Thus a tooth that is normally sensitive, can be made insensitive to hot or cold. Secondly, a tooth which would normally respond to a dental pulp tester current on the order of 20 volts, or at a setting of three on a scale of 14, can be raised to a setting of 14, the maximum output for this device.

One of the trial subjects was the Chairman of the Department at Forsythe who had good analgesia by transdental stimulation. With the pulp tester set at 14, he felt nothing; the technician made the mistake of turning off the transdental stimulation and he almost jumped up to the ceiling. The usefulness of this technique while filling teeth is now under study. The stringent human use committee at this institution has approved its use in dental patients attesting to its effectiveness.

A.  
I would like to comment on some experience using transcutaneous stimulation in an attempt to study the mechanisms of pain in normal volunteers. One finds that the tol-

erance to pain being induced by applied electric shock is changed by transcutaneous stimulation. It is also changed in extremities other than the one you are transcutaneously stimulating. With brief periods of stimulation up to 30 seconds, one sometimes finds persisting up to 15 minutes not only a change in pain tolerance, but also a blocking of cortical potentials; they are at first blocked totally and then gradually return. We feel that these studies have reinforced the idea of the gate theory of pain; they also make us happier in appreciating the fact that after stimulation ceases, patients themselves tend to note relief which at times lasts for many hours or perhaps even permanently.